

Eco Preparation 1600 mm Worktop Cupboard with Upstand

ITEM # _____

MODEL # _____

NAME # _____

SIS # _____

AIA # _____

132865 (MS1617N)

 WorkTop Cupboard, with
 100mm upstand, 1600mm

Short Form Specification

Item No. _____

Made entirely from stainless steel. Inner welded frame in stainless steel. Unique connection of panels to inner frame. Worktop in 304 AISI stainless steel (50mm high) incorporates a layer of sound deadening material and has upturned edges. Upstand (h=100m

Main Features

- Ideal for central positioning in the kitchen, either as island installation or back to back.
- Worktop cupboard can be mounted on 125 mm diameter castors (2 with brakes) using the optional accessory kit.
- Handles in stainless steel for better hygiene and reliability.
- Sturdiness, stability and reliability of table accurately tested.
- 100 mm upstand with 13mm depth and 10 mm radiused corner, designed to be used against a wall.

Construction

- 40 mm worktop in 304 AISI stainless steel.
- Inner welded frame in stainless steel to guarantee superior strength and stability.
- Handles directly built into the sliding doors.
- Equipped with intermediate shelf which can be positioned at three different heights.
- Intermediate shelf in stainless steel with riveted corners and trasversal reinforcement in stainless steel.
- Sturdy sound-deadened sliding doors on tracks located flush to the front of the frame.
- Easy access to the cupboard interior on all lengths guaranteed by the use of only 2 doors.
- Constructed entirely in stainless steel to offer maximum durability.
- Constructed entirely in stainless steel to offer maximum durability.
- Base panel has 40mm high profile, is 8/10 in thickness with upturned edges and bar reinforcement. It is welded to legs for further structure reinforcement.
- 304 AISI stainless steel feet, 150 mm high and 54 mm in diameter, adjustable by -35/+25 mm.

Optional Accessories

- Wheel kit for cupboards, 4 wheels (2 with brakes), D=1000 mm PNC 855299

APPROVAL: _____

Front

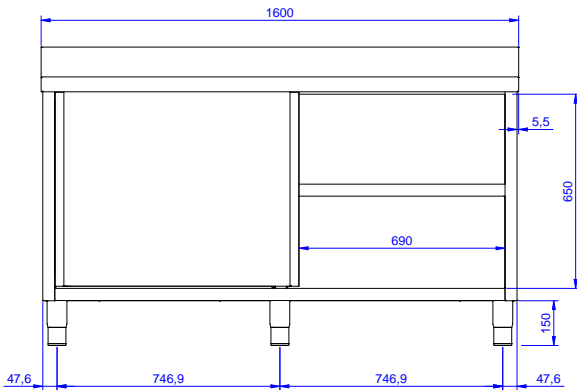

Side

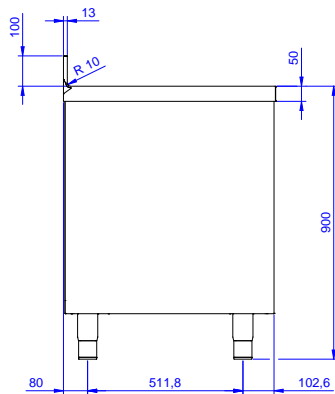

Top

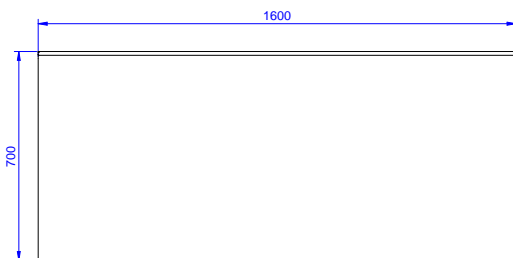
Key Information:

Cabinet width:		
132865 (MS1617N)	1545 mm	
Cabinet depth:	645 mm	
Cabinet height:	610 mm	
External dimensions, Width:	1600 mm	
External dimensions, Depth:	700 mm	
External dimensions, Height:	1000 mm	
Upstand Dimensions, Height:	100 mm	
Upstand Dimensions, Depth:	13 mm	
Upstand Dimensions, Radius:	R=10	
Worktop thickness:	50 mm	
Net weight:	65 kg	